

JENSEN®

WALL MOUNTABLE DOCKING MUSIC SYSTEM WITH CD FOR iPod and iPhone

Made for



iPod



iPhone



USER MANUAL

JiMS-260i

(iPod/iPhone Not Included)

PLEASE READ THIS USER MANUAL COMPLETELY BEFORE OPERATING THIS UNIT AND RETAIN THIS BOOKLET FOR FUTURE REFERENCE.

DEAR JENSEN® CUSTOMER

Selecting fine audio equipment such as the unit you've just purchased is only the start of your musical enjoyment. Now it's time to consider how you can maximize the fun and excitement your equipment offers. This manufacturer and the Electronic Industries Association's Consumer Electronics Group want you to get the most out of your equipment by playing it at a safe level. One that lets the sound come through loud and clear without annoying blaring or distortion and, most importantly, without affecting your sensitive hearing. Sound can be deceiving. Over time your hearing "comfort level" adapts to higher volumes of sound. So what sounds "normal" can actually be loud and harmful to your hearing. Guard against this by setting your equipment at a safe level BEFORE your hearing adapts.

To establish a safe level:

- Start your volume control at a low setting.
- Slowly increase the sound until you can hear it comfortably and clearly, and without distortion.

Once you have established a comfortable sound level:

- Set the dial and leave it there.

Taking a minute to do this now will help to prevent hearing damage or loss in the future. After all, we want you listening for a lifetime.

We Want You Listening For a Lifetime

Used wisely, your new sound equipment will provide a lifetime of fun and enjoyment. Since hearing damage from loud noise is often undetectable until it is too late, this manufacturer and the Electronic Industries Association's Consumer Electronics Group recommend you avoid prolonged exposure to excessive noise.

Customer's Record:

The serial number of this product is found on its back cover. You should note the serial number of this unit in the space provided as a permanent record of your purchase to aid in identification in the event of theft or loss.

Model Number: JiMS-260i

Serial Number: _____

IMPORTANT SAFETY INSTRUCTIONS

When used in the directed manner, this unit has been designed and manufactured to ensure your personal safety. However, improper use can result in potential electrical shock or fire hazards. Please read all safety and operating instructions carefully before installation and use, and keep these instructions handy for future reference. Take special note of all warnings listed in these instructions and on the unit.

1. Read these instructions – All the safety and operating instructions should be read before the appliance is operated.
2. Keep these instructions – The safety and operating instructions should be kept for future reference.
3. Heed all warnings – All warnings on the appliance and in the operating instructions should be adhered to.
4. Follow all instructions – All operation and use instructions should be followed.
5. Do not use this apparatus near water – The appliance should not be used near water; for example, near a bath tub, washbowl, kitchen sink, laundry tub, in a wet basement, or near a swimming pool.
6. Clean only with dry cloth – The appliance should be cleaned only as recommended by the manufacturer.
7. Do not block any ventilation openings. Install in accordance with the manufacturer's instructions. The appliance should be situated so that its location or position does not interfere with its proper ventilation. For example, the appliance should not be situated on a bed, sofa, rug, or similar surface that may block the ventilation openings; or placed in a built-in installation, such as a bookcase or cabinet that may impede the flow of air through the ventilation openings.
8. Do not install near any heat sources such as radiators, heat registers, stoves, or other apparatus (including amplifiers) that produce heat.
9. Protect the power cord from being walked on or pinched particularly at plugs, convenience receptacles, and the point where they exit from the apparatus.
10. The system has an AC plug and will only fit into matching AC outlets. This is a safety feature to reduce the possibility of electric shock. If the plug will not fit in your AC outlets, you should have the outlet changed by qualified licensed electrician. Do not use an adaptor to make the plug fit into your outlet. This defeats the safety feature and could expose you to electric shock.
11. Only use attachments / accessories specified by the manufacturer.
12. Unplug this apparatus during lightning storms or when unused for long periods of time.
13. Refer all servicing to qualified service personnel. Servicing is required when the apparatus has been damaged in any way, such as power-supply cord or plug is damaged, liquid has been spilled or objects have fallen into the apparatus, the apparatus has been exposed to rain or moisture, does not operate normally, or has been dropped.
14. This appliance shall not be exposed to dripping or splashing water and that no object filled with liquids such as vases shall be placed on the apparatus.
15. Power Sources – The appliance should be connected to a power supply only of the type described in the operating instructions or as marked on the appliance. Do not overload wall outlet.
16. Danger of explosion if battery is incorrectly replaced. Replace only with the same or equivalent type.
17. Do not attempt to dismantle, open or repair this product yourself. If a fault occurs, seek advice from your local qualified service technician or contact the distributor via the telephone number at the back of this instruction manual.
18. Caution marking and nameplate are located on back of product.

CAUTION

CLASS 1 LASER PRODUCT

CLASS 1 LASER PRODUCT
APPAREIL LASER DE CLASSE 1
PRODUCTO LASER DE CLASE 1

CAUTION
INVISIBLE LASER RADIATION
WHEN OPEN AND INTERLOCKS
DEFEATED
AVOID EXPOSURE TO BEAM.



This product contains a low power laser device.

Note: This product complies with DHHS Rule 21 Subchapter J at date of manufacture.

Follow the advice below for safe and appropriate operation.

ON PROTECTION AGAINST LASER ENERGY EXPOSURE

- As the laser beam used in this compact disc player is harmful to the eyes, do not attempt to disassemble the casing.
- Stop operation immediately if any liquid or solid object should fall into the cabinet.
- Do not touch the lens or poke at it. If you do, you may damage the lens and the player may not operate properly.
- Do not put anything in the safety slot. If you do, the laser diode will be ON when the CD door is still open.
- This unit employs a laser. The use of controls or adjustment or performance of procedures other than those specified here may result in exposure to hazardous radiation.

ON PLACEMENT

- Do not use the unit in places which are extremely hot, cold, dusty or humid.
- Place the unit on a flat and even surface.
- Do not restrict the air-flow of the unit by placing it in a place with poor ventilation, by covering it with a cloth or by placing it on a carpet.

ON CONDENSATION

- When left in a heated room where it is warm and damp, water droplets or condensation may form inside the unit.
- When there is condensation inside the unit, the unit may not function normally. Let it stand for 1 to 2 hours before turning the power on, or gradually heat the room up and dry the unit before use.

Should any trouble occur, remove the power source and refer servicing to qualified personnel.

PRECAUTION FOR USE

- **UNPACK ALL PARTS AND REMOVE PROTECTIVE MATERIAL.**
- **DO NOT CONNECT THE UNIT TO THE MAINS BEFORE CHECKING THE MAINS VOLTAGE AND ALL OTHER CONNECTIONS HAVE BEEN MADE.**
- **DO NOT COVER ANY VENTS AND MAKE SURE THAT THERE IS A SPACE OF SEVERAL CENTIMETERS AROUND THE UNIT FOR VENTILATION.**

IMPORTANT NOTES

Avoid installing the unit in locations described below:

- Places exposed to direct sunlight or close to heat radiating appliances such as electric heaters.
- Places subject to constant vibration.
- Dusty, humid or moist places.

COMPLIANCE WITH FCC REGULATIONS

This device complies with Part 15 of the FCC Rules. Operation is subject to the following two conditions:

- (1) this device may not cause harmful interference, and
- (2) this device must accept any interference received, including interference that may cause undesired operation.

NOTE : This equipment has been tested and found to comply with the limits for a Class B digital device, pursuant to Part 15 of the FCC Rules. These limits are designed to provide reasonable protection against harmful interference in a residential installation. This equipment generates, uses and can radiate radio frequency energy and, if not installed and used in accordance with the instructions, may cause harmful interference to radio communications. However, there is no guarantee that interference will not occur in a particular installation. If this equipment does cause harmful interference to radio or television reception, which can be determined by turning the equipment off and on, the user is encouraged to try to correct the interference by one or more of the following measures:

- Reorient or relocate the receiving antenna.
- Increase the separation between the equipment and receiver.
- Connect the equipment into an outlet on a circuit different from that to which the receiver is connected.
- Consult the dealer or an experienced radio/TV technician for help.

CAUTION: Changes or modifications not expressly approved by the party responsible for compliance could void the user's authority to operate the equipment.

PROTECT YOUR FURNITURE

This model is equipped with non-skid rubber 'feet' to prevent the product from moving when you operate the controls. These 'feet' are made from non-migrating rubber material specially formulated to avoid leaving any marks or stains on your furniture. However certain types of oil based furniture polishes, wood preservatives, or cleaning sprays may cause the rubber 'feet' to soften, and leave marks or a rubber residue on the furniture. To prevent any damage to your furniture we strongly recommend that you purchase small self-adhesive felt pads, available at hardware stores and home improvement centers everywhere, and apply these pads to the bottom of the rubber 'feet' before you place the product on fine wooden furniture.

PRODUCT FEATURES

The JiMS-260i is an iPod/iPhone Docking Music System with incorporates the following features:

- Player / Charger for iPod nano, iPod touch, iPod classic, iPod video and iPhone.
- Audio CD player with CD and CD-R/RW compatibility
- CD Playback modes :
 - Repeat one / Repeat All
 - Program playback up to 20 tracks
- FM digital tuner with 10 presets
- Auxiliary input jack
- Pre-set EQ control (Rock, Classic, Jazz & Pop)
- Digital volume control
- Sleep timer function
- Wake Timer function - Wake to radio, CD or your iPod/iPhone
- Video Line-out provides video signal output when iPod/iPhone with video is docked

INSTALLATION

FOR TABLE TOP USE

Attach the stand to the main unit as shown in figure 1a below. Attach the stands to the speakers as shown in figure 1b below.

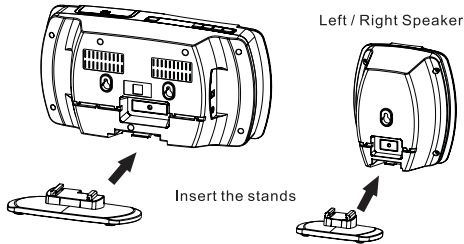
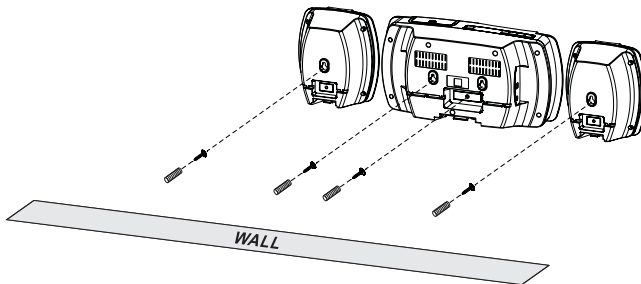
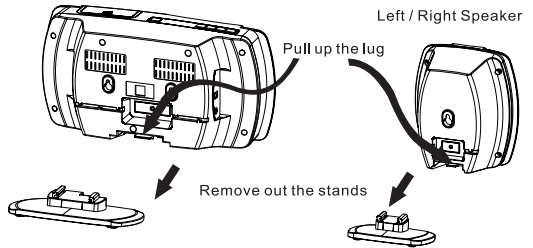

Fig. 1a

Fig. 1b

FOR WALL MOUNTING

- 1) Detach the stands from both speakers and from the main unit.
- 2) Use the supplied wall-mounting template to make anchor hole marks on the wall. Make sure the marks are level before drilling.
- 3) Drill 1/4" holes on the marks.
- 4) Insert the included plastic anchors into the holes and push in until they are flush with the wall.
- 5) Insert the included screws into the anchors and tighten until the screw head is about 1/4" away from the wall. Line up the slots located on the back of the main unit and speakers with the screws in the wall. See illustration below.



NOTE: This unit is not magnetically shielded and may cause color distortion on the screen of some TVs or video monitors. To avoid this, you may need to move the unit further away from the TV or monitor if unnatural color shifts or image distortion occurs.

LOCATION OF CONTROLS



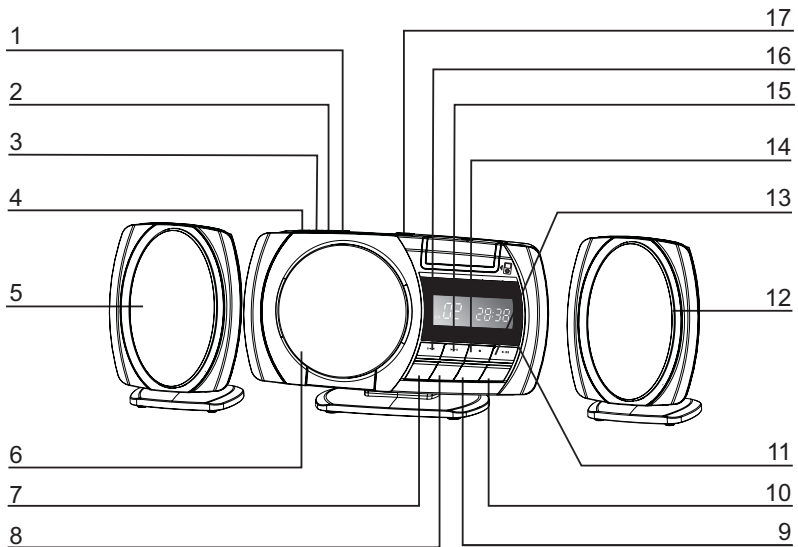

Main Unit

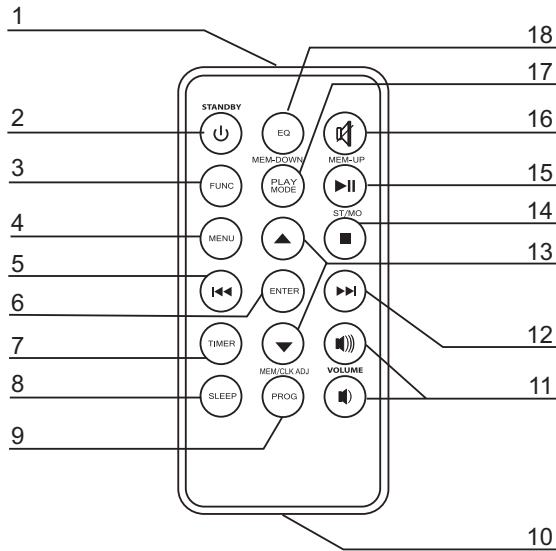

1. Function Selection Button
2. Volume+ Button
3. Volume- Button
4. Power On/Standby  Button
5. Left Speaker
6. CD Door
7. Sleep Button
8. Timer Button
9. CD Program; FM Station Memory Set; Clock Adjust Button
10. CD/iPod Play Mode Selection; FM Memory Down
11. Remote Infrared Sensor
12. Right Speaker
13. Play/Pause  Button; FM Memory Up Button
14. CD Stop  Button ; FM Stereo/Mono selection
15. CD/iPod Skip Search Forward  Button; FM Radio Tuning+ ; Clock/Timer adjust up
16. CD/iPod Skip/Search Backward  Button; FM Radio Tuning- ; Clock/Timer adjust down
17. CD door Open

Remote Control



1. Infra-red Transmitter
2. Power On/Standby  Button
3. Function Selection Button
4. iPod Menu Button
5. CD/iPod Skip/Search Backward  Button; FM Radio Tuning- ; Clock/Timer adjust down
6. iPod Enter Button
7. Timer Button
8. Sleep Button
9. CD Program; FM Station Memory Set; Clock adjust Button
10. Battery Compartment
11. Volume+/- Buttons
12. CD/iPod Skip Search Forward  Button; FM Radio Tuning+ ; Clock/Timer adjust up
13. iPod Menu Scroll Up/Down Button
14. CD Stop  Button; FM Stereo/Mono selection
15. Play/Pause  Button; FM Memory Up Button
16. Mute Button
17. CD/iPod Play Mode Selection; FM Memory Down Button
18. EQ mode selection Button

GETTING STARTED

SPEAKER CONNECTION

Unpack the unit carefully. The speaker wires are already attached to main unit. Handle with care to avoid damaging the wires. Place the left speaker on the left side of the main unit and place the right speaker on the right side of the main unit.

ANTENNA CONNECTION

FM: Untie and fully extend the FM Antenna wire for best reception.

POWER SUPPLY

This Music System operates on 120V AC~ 60Hz household power.

The remote control unit operates on one "CR2025" lithium battery (Included).

AC POWER CONNECTION

Connect the power cord to a 120V AC~ 60Hz power outlet.

Remarks:

In case of malfunction due to electrostatic discharge (ESD), reset the unit by disconnecting and reconnecting the AC CORD to reset and to resume normal operation.

CONNECTING THE AC POWER

An AC-DC Adaptor with 10V DC 2000mA output (included) is required for operating the main unit. Connect the AC-DC Adaptor to the unit and an AC outlet:

- 1.) Firmly and securely insert the DC plug of the adaptor into the DC Jack on the unit
- 2.) Plug the Adaptor plug into a power outlet rated at 120V AC~ 60Hz.

Remote Control

The remote control operates on one CR2025 battery (included). To activate the remote control, remove the insulation tab inserted in the battery compartment.

When the operation of the remote control becomes intermittent or unsatisfactory, replace the original battery with a new 3-volt lithium battery.

- 1.) Slide out the battery holder from the remote control case.
- 2.) Replace the 3V CR2025 battery. Be sure the battery is installed correctly. The remote will not work if the battery is installed with the wrong polarity.

CAUTION: Danger of explosion if the battery is replaced incorrectly. Replace only with the same type battery.

- 3.) Insert the battery holder back into the battery slot.

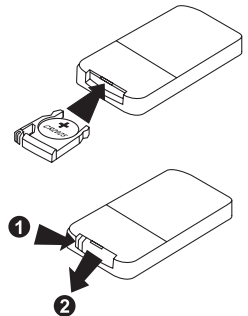

NOTE: Only use a well-known brand of cell battery to ensure the longest life and best performance.

BATTERY CARE

- i. If the unit is not used for an extended period of time, remove the battery. An old or leaking battery can cause damage to the unit and may void the warranty.
- ii. Do not dispose batteries in fire. Batteries may leak or explode.
- iii. Do not try to recharge batteries that are not intended to be recharged; they can overheat, rupture and leak (Follow battery manufacturer's directions).
- iv. Only an adult should replace the battery.

CLOCK SETTING

NOTE:

- i. The clock has to be set the first time you plug the unit in.
- ii. The Clock is set to default in 12 Hour mode.

With the unit in standby mode (power OFF):

Setting 12/24 Hour format

- 1.) Press and hold the **CLOCK ADJUST (CLK. ADJ)** button until 12H or 24H appears flashing on the display. Press the **◀◀** or **▶▶** buttons to switch between 12 hour (12H) or 24 hour (24H) format.
- 2.) Press the **CLK.ADJ** button to confirm, the Hour digit(s) will flash to prompt for input.

Setting the Clock

- 3.) To set the hour, repeatedly press the **◀◀** or **▶▶** buttons to select the correct hour digit(s). Press and hold the buttons to speed the forward or reverse scanning of the digits.

NOTE: Make sure the hour is set so that **AM** or **PM** is displayed correctly.

- 4.) Press the **CLK.ADJ** button to confirm the hour setting and the minute digits flash to prompt for input.
- 5.) To set the minutes, repeatedly press the **◀◀** or **▶▶** buttons to select the correct minute digits. Press and hold the buttons to speed the forward or reverse scanning of the digits.
- 6.) Press the **CLK.ADJ** button again to complete the clock setting.

RADIO OPERATIONS

Tuning the Radio

- 1.) Press the **POWER ON/STANDBY**  button located on top of the main unit or on the remote control to turn on the unit. Press the **FUNCTION** button repeatedly to select the FM mode.
- 2.) Repeatedly press the **◀◀** or **▶▶** buttons to manually tune to a desired station.

- 3.) To automatically search for stations with strong signals, press and hold either the **◀◀** or **▶▶** button until the frequency read out on display begins to scan then release the button. The tuner will stop on the first strong station signal it finds.
- 4.) Adjust the sound level by pressing the **VOLUME + / -** buttons.
- 5.) Press the **TIMER** button to show the current time on the display. The time will revert back to the station frequency readout after 5 seconds.

Notes:

- Manual tune to select weaker stations that might be bypassed during automatic tuning.
- If the automatic tuning does not stop on the exact frequency of the station, for example, it stops on 100.9 MHz instead of 100.8 MHz, use the manual tuning method to "fine tune" to the exact frequency of the desired station.
- If a station is broadcasting in Stereo, the unit will automatically receive the stereo broadcast.

Hints for the Best Reception

- To obtain the best FM/FM Stereo reception, unwrap and fully extend the FM Antenna and adjust the position of the wire for best station reception.

Setting the Radio Station Presets

The unit allows you to store up to 10 FM stations for easy recall at any time.

- 1.) In the FM mode, tune to the radio station you want to store in memory using the **◀◀** or **▶▶** buttons.
- 2.) Press the **MEM** button. The preset channel number "P01" will be flashing on display.
- 3.) To change the preset channel number location, press the **MEM-UP** or **MEM-DOWN** buttons to step through the preset locations (P01 – P10).
- 4.) To confirm the preset location, press the **MEM** button.
- 5.) To store up to 10 FM station presets, repeat steps 1 to 4 above.

Note:

1. There is a 5 seconds delay when programming, after 5 seconds, the unit will automatically switch back to normal tuner mode.
2. You can overwrite a present station by overwriting and storing the new frequency in its place.

Recall Preset Radio Stations

- 1.) Set the unit to FM mode.
- 2.) Press the **MEM-UP** or **MEM-DOWN** button to select preset channel.

LISTENING TO iPod/iPhone

CONNECTING

If the docking port will not be used for an extended period of time, it is recommended to cover the docking port by using the "Dock Cover (included)".

1.) Use the iPod adapter included with your iPod and insert it into the docking area. No Adaptor is required if you use an iPhone. Your iPod / iPhone can now be inserted into the docking port by placing the connector on the bottom of the iPod onto the connector in the docking bay.

Note: Please be careful when placing the iPod / iPhone into the docking bay to avoid damaging the 30-pin connector on the iPod/iPhone or on the docking system.

2.) Press the **POWER ON/STANDBY** button to turn on the unit.

3.) Press the **FUNCTION** button repeatedly to select iPod mode. The iPod/iPhone will start playing and charging automatically. You can also play the iPod/iPhone by pressing iPod/iPhone PLAY/PAUSE **▶||** button when the unit is at another mode.

4.) Press the iPod/iPhone PLAY/PAUSE **▶||** button to pause or resume iPod playback.

5.) Adjust the sound level by pressing the **VOLUME ▼ / ▲** buttons.

6.) Repeatedly press the **EQ** button on the remote to change the EQ setting. There are four different EQ settings available to enhance the playback sound (ROCK/CLASSICAL/JAZZ/POP).

Note: The volume level cannot be adjusted using the volume control on your iPod/iPhone after being docked.

7.) The iPod/iPhone charges in all modes even during playback.

iPod/iPhone playback control:

- Press the iPod/iPhone PLAY/PAUSE **▶||** button to pause or resume the iPod/iPhone playback;
- Press the SKIP **◀◀** or **▶▶** buttons to skip to the next or previous song;
- Press and hold the SKIP **◀◀** or **▶▶** buttons for fast-forwarding or fast-rewinding during playback.
- From the remote, press the **MENU** button, **ENTER** button and **▲ / ▼** buttons on the remote control to control the iPod menu, scroll menu up/down and enter selection.
- Press the **PLAY MODE** button on the remote to repeat one or repeat all song / file playback.

VIDEO OUT FROM THE iPod/iPhone

1. You can connect this unit to a television or other video display that has a composite video input.
2. Securely dock your iPhone or iPod with video.
3. Connect one end of an RCA cable (not included) to rear RCA video jack on the unit.
4. Connect the other end of the RCA cable to VIDEO IN of television or video display.
5. Press the **FUNCTION** button to select iPod/iPhone mode.
6. Select a movie from your iPod/iPhone menu.
7. iPod: On the main menu choose video then select video setting.
8. iPod: Make sure the TV Out section is set to "ON".
9. iPod: Switch back to the movie library and play the movie of your choice.

Note: Video out will be automatic when using an iPod touch or iPhone.

CD OPERATIONS

NOTE: This player will not only play commercial CDs, but also self-complied CD-D/RW discs. Do not attempt to play CD-ROM, CDI, VCD, DVD or computer CDs.

Notes on CD-R/RW Discs

- Because of non-standardized format definition/production of CD-R/RW CD, playback quality & performance are not guaranteed.
- Manufacturer is not responsible for the playability of CD-R/RW CD due to recording conditions such as PC performance, writing software, media ability, etc.
- Do not attach a label or seal to either side of the CD-R/RW disc. It may cause a malfunction.
- Do not load a blank CD-R/ RW disc. It will take over 30 seconds to read the disc. The disc may be damaged if you try to open the CD Door while reading the disc.

The following procedures can be accomplished by using the remote or controls on the unit.

Loading The Discs

1. Press the **POWER ON/STANDBY**  button to turn the unit on.
2. Press the **FUNCTION** button to select the CD mode.
3. Press the **OPEN** button on the top panel to open the CD door, the icon "OPEN" shows on the display;
4. Hold the CD by the edges with CD graphic side facing front and insert it into the CD tray. Make sure the disc label is facing you.
5. Press the **CLOSE** mark position on the CD door to close the CD door.
6. When the disc is loading, " - - - - " will appear and flashing on the display.

Normal Playback

After loading the disc, the disc will begin spinning and the total number of the tracks on the disc will be shown on the display for a while. Then the CD Player will automatically play the CD start from the first track and the display will show the playback time of the current track.

NOTE: If there is no disc in the unit or the loaded disc is not recognized by this player, "no cd" will be shown on the display.

Play/Pause Control

To pause temporarily during the CD playback, press the **▶||** button. The disc will pause and the current playing track number will show on the display and flashing. Press the **▶||** button again to resume playback.

Stop Control

To stop the CD playback, press the **■** button on the unit or on the remote control. The CD will stop playback and the whole tracks of the disc will indicate on the display.

Skip/Search Track

During playback, press the **◀◀** or **▶▶** button to skip to the next or previous tracks.

During playback, press and hold the **◀◀** or **▶▶** button to search forwards or backwards through the current track. When the desired part of the track is reached, release the button and playback will resume.

To Check the Actual Time:

In CD mode, press the **TIMER** button once to check the actual time. The clock will display for 5 seconds and then go back CD track / play time mode a few seconds.

Play Mode Control

Repeat the Current Track

- In CD playback mode, select the track to be repeated and begin playback. Tap the **PLAY MODE** button once. The "RPT" icon will appear and flash on the display. The selected track will be repeated playback continuously.

Repeat All Track

- Tap the **PLAY MODE** button twice. The "RPT" icon will be shown on the display steadily and all tracks on the disc will be repeated playback continuously.
- Tap the **PLAY MODE** button again to cancel repeat playback function, and normal playback will resume. The "RPT" will be disappeared on the display.

RANDOM Playback

- The Random playback feature allows you to play all the tracks on the current disc in a random order. This function can be selected when the disc is playing or in stop mode. Press and hold the **PLAY MODE** button to enter random playback mode. The "RDM" will be indicated on the display.
- Press and hold the **PLAY MODE** button to cancel the random play mode and resume to normal playback.

Programmed CD Playback

The CD player can be programmed to play any sequence of up to 20 tracks. In CD mode,

1. Load a compact disc into the CD compartment.
2. After load the disc, press the **■ STOP** button before starting the programming.
3. Press **PROG** button, "MEM" "01:--" indicates and flashes on the display for 30 seconds.
4. Press the **◀▶** or **▶▶** button to select the desired track to be programmed.
5. Press **PROG** button again to save the selected track. The programmed track number "02 --" indicates on the display.
6. Press the **◀▶** or **▶▶** button to select the next desired track to be programmed.
7. Press the **PROG** button to save the selected track.
8. Repeat steps 6-7 to program up to 20 tracks.
9. Press the **▶▶** button to play according to the programmed track when programming is completed.

Clear Program (Resume Normal Playback)

Press STOP button twice in the program mode, or release the CD door, or change to another mode to clear the programmed tracks.

SLEEP TIMER

The sleep timer allows you to turn the unit off after a designated time is reached.

- 1.) To activate the sleep timer, turn the unit on and either load a CD, dock your iPod/iPhone or tune to the desired radio station.
- 2.) Tap the **SLEEP** button and the SLEEP icon appears on the display.
- 3.) Repeatedly tap the **SLEEP** button to select a sleep time. The unit will turn off after 10, 20, 30, 40, 50, 60, 70, 80 or 90 minutes. Wait 5 seconds after your selection for the unit to confirm the selection, the unit will play for the selected length of time then automatically turn off.
- 4.) To cancel the sleep timer, press the **SLEEP** buttons until timer shows "OFF", the "SLEEP" indicator will disappear from the display after 5 seconds.
- 5.) To turn the unit off before the selected length of time, press the **POWER** **⏻** button at any time.

WAKE TIMER OPERATIONS

Setting the wake timer

When the unit is in standby mode,

- 1.) Press and hold the **TIMER** button until TIMER icon appears and the hour digit(s) flashes.
- 2.) Press the **◀▶** or **▶▶** buttons to set the hour.
- 3.) Press the **TIMER** button to confirm, the minute digits flash to prompt for input.
- 4.) Press the **◀▶** or **▶▶** buttons to set the minutes.

- 5). Press the **TIMER** button to confirm, wake up source flashing. Press the **◀◀** or **▶▶** button to select a source you want to wake to.
 - 6). Press the **TIMER** button to confirm, Press the **◀◀** or **▶▶** buttons to set the wake volume level.
 - 7). Press **TIMER** button to confirm,
- Note:** When “Wake to Radio” is selected, make sure the radio station you want to wake to is tuned. If “Wake to iPod” or “Wake to CD” is selected but an iPod / iPhone is not docked or CD is not loaded, the alarm source will be redirected to the radio automatically when the wake time is reached.
- 8.) If you want to switch off the wake timer, tap the **TIMER** button and the **TIMER** icon disappears from the display.
 - 9.) When the wake time is reached, the selected source, radio, CD or iPod/iPhone will begin to play. The wake timer continues to sound for 60 minutes if no button is pressed and the unit will reset itself for the following day.
 - 10.) To stop the wake timer after the preset time is reached and the source begins to play, press either the **POWER** button or the **TIMER** button once.

PRESET EQ (REMOTE CONTROL ONLY)

This unit provides 4 different EQ modes to enhance your listening experience. You can select the desired effect by pressing the “EQ” button on remote control repeatedly at following sequence:

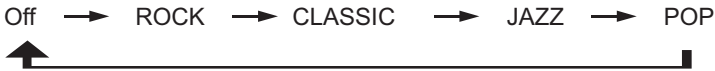

Mute Button (By Remote Control)

- Press the **MUTE** button on remote control to mute the sound output from speaker temporarily, **MUTE** icon will appear on display and flashing.
- Press the **MUTE** button again to resume to normal speaker playback.

AUXILIARY INPUT

This unit provides an auxiliary audio signal input jack for connecting external audio devices like MP3 players, CD players and older, non-dockable iPods (except iPod shuffle 3rd gen) and listen to your external source through the speakers of this system.

1. Use an audio cable (not included) with one 3.5 mm stereo plug on each end of the cable.
2. Plug one end into the Aux-in jack on the main unit and the other end of the cable into the Line-out Jack or Headphone Jack of your external audio device.
3. Turn on the external audio device.

4. To select auxiliary audio input, press the **FUNCTION** button to select "AUX" mode.
5. The volume level can now be controlled through the main unit. Operate all other functions on the auxiliary device as usual.

Note:

- (1) If the Line Out Jack of your external device is connected, then you only need to adjust the volume control of this system. If the Headphone Jack of your external device is connected, then you may need to adjust both the volume control of your external device and the volume control of this system to find the most desirable volume setting.
- (2) Press the **POWER**  button to turn off the system when you finish listening. Don't forget to switch off the power on your external device as well.

RESETTING

If the system does not respond or has erratic operation, you may have experienced an electrostatic discharge (ESD) or a power surge that triggered the internal computer to shut down automatically. If this occurs, simply disconnect the main power, wait one minute and reconnect the main power again.

Note:

Disconnecting the power will reset the internal computer after a power surge, but it will also erase all of the settings. After turning "ON" the unit, you will need to reset the settings again.

CARE AND MAINTENANCE

1. Avoid operating your unit under direct sunlight or in hot, humid or dusty places.
2. Keep your unit away from heating appliances and sources of electrical noise such as fluorescent lamps or motors.
3. For better Clock Display clarity, avoid operating the unit under direct sunlight or in strong room illumination.
4. Unplug the unit from the electrical power outlet immediately in case of malfunction.

COMPACT DISC CARE

- Handle the disc only by its edges. Never allow your fingers to come in contact with the shiny, unprinted side of the disc.
- Do not attach adhesive tape, stickers etc., to the disc label.
- Clean the disc periodically with soft, lint-free, dry cloth. Never use detergents or adhesive cleaners to clean the disc. If necessary, use a CD cleaning kit.
- If disc skips or gets stuck on a section of the disc, it is probably dirty or damaged (scratched).

- When cleaning the disc, wipe in straight lines from the center of the disc to the edge of the disc. Never wipe in circular motions.
- To remove a disc from its storage case, press down on the center of the case and lift the disc out, holding it carefully by the edges.
- Fingerprints and dust should be carefully wiped off the disc's recorded surface with a soft cloth. Unlike conventional records, compact discs have no grooves to collect dust and microscopic debris so gently wiping with a soft cloth should remove most particles.



CLEANING THE UNIT

- To prevent fire or shock hazard, disconnect your unit from the AC power source when cleaning.
- The finish on the unit may be cleaned with a dust cloth and cared for as other furniture, Use caution when cleaning and wiping the plastic parts.
- If the cabinet becomes dusty wipe it with a soft dry dust cloth. Do not use any wax or polish sprays on the cabinet.
- If the front panel becomes dirty or smudged with fingerprints it may be cleaned with a soft cloth slightly dampened with a mild soap and water solution. Never use abrasive cloths or polishes as these will damage the finish of your unit.

CAUTION: Never allow any water or other liquids to get inside the unit while cleaning.

TROUBLESHOOTING GUIDE

Symptom	Possible Problem	Solution
The unit does not respond (no power).	AC Adaptor is not plugged into a wall outlet or the connector is not plugged into the power supply jack on the back of the unit.	Plug the AC adaptor into a wall outlet and plug the connector into the supply jack on the unit.
	Wall outlet is not functioning.	Plug another device into the same outlet to confirm the outlet is working.
iPod does not dock properly.	Using no/wrong iPod Adaptor.	Make sure the dock insert is the proper fit for your iPod.
	iPod does not install properly.	Remove your iPod from the dock and check for obstruction on the connectors in the dock and on your iPod. Then reseat it in the dock.
iPod/iPhone does not respond to the speaker system.	iPod/iPhone is not installed properly.	Remove your iPod/iPhone from the dock and check for obstruction on the connectors in the dock and on your iPod/iPhone. Then reseat it on the dock.
	Your iPod/iPhone is locked up.	Please make sure that your iPod/iPhone is working properly before docking into the unit. Please refer to your iPod/iPhone manual for info on resetting the iPod/iPhone.
iPod/iPhone does not charge.	Unit turned to CD or radio mode.	Select other modes for iPod charging.
	iPod/iPhone is not installed properly.	Remove your iPod/iPhone from the dock and check for obstruction on the connectors in the dock and on your iPod/iPhone. Then reseat it in the dock.
	iPod/iPhone is locked up/frozen. iPod/iPhone battery has problem.	Please make sure your iPod/iPhone is working properly before docking into the unit. Please refer to your iPod/iPhone manual for details on resetting.
FM STEREO indicator does not light up	You have tuned to a mono station or the station is too weak.	Select another FM station or extend or rotate the wire antenna for best reception.
	FM MONO MODE is set.	Set the FM MODE to STEREO.
Sound is distorted.	Volume level is set too high.	Decrease the volume.
	Sound source is distorted.	If the iPod/iPhone original sound source is of poor quality, distortion and noise are easily noticed with high-power speakers. Try a different audio source such as a music CD. If you are using an external sound source like older generation of iPod, try reducing the output volume on the device itself. Also try turning bass boost OFF or change the EQ setting.
CD Player does not play.	CD mode is not selected.	Press the FUNCTION switch to select CD mode.
	CD is not installed or installed incorrectly.	Press the CD onto spindle, printed side facing up.
CD skips while playing.	Disc is dirty or scratched.	Wipe with cloth or use another disc.
Unit gets warm after extended play at high volume.	This is normal.	Turn the unit off for a period of time or lower volume.

SPECIFICATIONS

Power Requirement

Main Unit

AC-DC adaptor

Input: AC 120V~ 60Hz

Output: DC10V / 2000mA

Remote Control

1 x 3V CR2025 Lithium Battery

Frequency Range

Radio

FM 87.5 - 108 MHz, 0.1 MHz tuning step

“Made for iPod” and “Made for iPhone” mean that an electronic accessory has been designed to connect specifically to iPod and iPhone, respectively, and has been certified by the developer to meet Apple performance standards. Apple is not responsible for the operation of this device or its compliance with safety and regulatory standards.

iPhone, iPod, iPod classic, iPod nano, iPod shuffle, and iPod touch are trademarks of Apple Inc., registered in the U.S. and other countries.

**90 DAY LIMITED WARRANTY AND SERVICE
VALID IN THE U.S.A ONLY**

SPECTRA MERCHANDISING INTERNATIONAL, INC. warrants this unit to be free from defective materials or factory workmanship for a period of 90 days from the date of original customer purchase and provided the product is utilized within the U.S.A. This warranty is not assignable or transferable. Our obligation under this warranty is the repair or replacement of the defective unit or any part thereof, except batteries, when it is returned to the SPECTRA Service Department, accompanied by proof of the date of original consumer purchase, such as a duplicate copy of a sales receipt.

You must pay all shipping charges required to ship the product to SPECTRA for warranty service. If the product is repaired or replaced under warranty, the return charges will be at SPECTRA's expense. There are no other express warranties other than those stated herein.

This warranty is valid only in accordance with the conditions set forth below:

1. The warranty applies to the SPECTRA product only while:
 - a. It remains in the possession of the original purchaser and proof of purchase is demonstrated.
 - b. It has not been subjected to accident, misuse, abuse, improper service, usage outside the descriptions and warnings covered within the user manual or non-SPECTRA approved modifications.
 - c. Claims are made within the warranty period.
2. This warranty does not cover damage or equipment failure caused by electrical wiring not in compliance with electrical codes or SPECTRA user manual specifications, or failure to provide reasonable care and necessary maintenance as outlined in the user manual.
3. Warranty of all SPECTRA products applies to residential use only and is void when products are used in a nonresidential environment or installed outside the United States.

This warranty gives you specific legal rights, and you may also have other rights which vary from state to state. TO OBTAIN SERVICE please remove all batteries (if any) and pack the unit carefully and send it freight prepaid to SPECTRA at the address shown below. IF THE UNIT IS RETURNED WITHIN THE WARRANTY PERIOD shown above, please include a proof of purchase (dated cash register receipt) so that we may establish your eligibility for warranty service and repair of the unit without cost. Also include a note with a description explaining how the unit is defective. A customer service representative may need to contact you regarding the status of your repair, so please include your name, address, phone number and email address to expedite the process.

IF THE UNIT IS OUTSIDE THE WARRANTY PERIOD, please include a check for \$50.00 to cover the cost of repair, handling and return postage. All out of warranty returns must be sent prepaid.

It is recommended that you contact SPECTRA first at 1-800-777-5331 or by email at custserv@spectrainintl.com for updated information on the unit requiring service. In some cases the model you have may be discontinued, and SPECTRA reserves the right to offer alternative options for repair or replacement.

SPECTRA MERCHANDISING INTERNATIONAL, INC.
4230 North Normandy Avenue,
Chicago, IL60634, USA.
1-800-777-5331

To register your product, visit the link on the website below to enter your information.
<http://www.spectrainintl.com/wform.htm>

Printed in China